

## 6kW cabinets, 1-3 x MHE

OPUS HE 24-4.5 OC2066 F  
OPUS HE 48-6.0 OC2066 F  
OPUS HE 60-6.0 OC2066 F  
OPUS HE 110-6.0 OC2066 F  
OPUS HE 125-6.0 OC2066 F  
OPUS HE 220-6.0 OC2066 F

## 12kW cabinets, 1-6 x MHE

OPUS HE 24-9.0 OC2066 F  
OPUS HE 48-12.0 OC2066 F  
OPUS HE 60-12.0 OC2066 F  
OPUS HE 110-12.0 OC2066 F  
OPUS HE 125-12.0 OC2066 F  
OPUS HE 220-12.0 OC2066 F

## 24kW cabinets, 1-12 x MHE

OPUS HE 24-18.0 OC2066 F  
OPUS HE 48-24.0 OC2066 F  
OPUS HE 60-24.0 OC2066 F  
OPUS HE 110-24.0 OC2066 F  
OPUS HE 125-24.0 OC2066 F  
OPUS HE 220-24.0 OC2066 F



### Configurable Load distribution

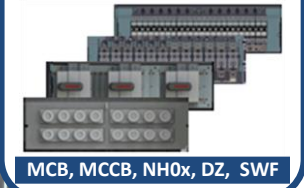

MCB, MCCB, NH0x, DZ, SWF

### Battery fuse alternatives



MCB MCCB Switch fuse

### VIDI Controller



### MHE Rectifiers 24V-220V

6kW cabinets, 1-3 pcs  
12kW cabinets, 1-6 pcs  
24kW cabinets, 1-12 pcs

### Inverters and DC/DC converters

### Configurable Battery shelves

4 shelves, e.g. 1 x 220V string  
3 shelves, e.g. 1 x 110V string  
2 shelves, e.g. 2x48V or 1x110V  
1 shelf, e.g. 2 x 24 or 1 x 48V  
No battery shelves



## Product Description

OPUS HE power systems are robust, free convection cooled, N+1 redundant backup power solutions for critical infrastructure applications such as transmission and distribution substations, process industries, railway signalling and substations and telecommunications.

OPUS HE Cabinet power systems consist of MHE rectifiers, VIDI+ controllers, Connections for mains and battery and load distribution MCB. System is configurable to match with requirements of the application. On top of 12 configurable relay alarms, system can be remotely monitored via modern communication protocols such as Ethernet TCP/IP, Modbus TCP/IP, SCADA IEC61850, SNMP and RS-232.

OC2066 2000x600x600mm standard cabinet systems deliver maximum 24 kW output power at 48, 60, 110, 125 and 220 VDC and 18 kW at 24 VDC output. Cabinets have standard configurations for 3/6/12 rectifier modules. Quantity of rectifiers, battery fuses, battery shelves, load distribution and many other features are configurable to match with requirements of the application.

## Features

- Efficiency up to 97%
- Convection cooling – no fans
- Outputs 24, 48, 60, 110, 125, 220 VDC
- Flexible design with full front cabling
- VIDI+ I/O controller, local and remote interfaces  
12 x relays, Ethernet, Modbus, IEC61850, SNMP, RS-232
- Configurable battery shelves, battery connection and load distribution
- Options: IP21 roof, BLVD contactor, battery block voltage monitoring, inverters & DC/DC converters
- Safety:  
Cabinet: EN61439-1, EN61439-2  
Low voltage switchgear controlgear assemblies  
Rectifiers: EN 62368-1, EN 50124-1 rail
- EMC:  
Cabinet: EN61439-1, EN61439-2  
Rectifiers: EN 61000-6-1 / -2 / -3 / -4 / -5  
EN 50121-4 rail, ETSI EN 300386 (48/60V)

# Technical Specifications

General construction		Environment and standards	
Cooling	Natural convection	Temp. range	-25 ... +60°C, see derating page 5, Start-up at -40°C
Protection	IP 20, Option IP21	Humidity max	95% relative humidity, non-condensing
Controller user interface	Display and local control in front door & web interface	Altitude	Max 3km, full power up to 2km above sea level Derating 2% per 100 m between 2-3km
Cabling	Default top entry Option bottom entry	Safety	Cabinet: EN61439-1, EN61439-2 Rectifiers: EN 62368-1, EN 50124-1 rail
Colour	Frame RAL 7037, door RAL 7024	EMC	Cabinet: EN61439-1, EN61439-2 Rectifiers: EN61000-6-1 / -2 / -3 / -4 Generic EN61000-6-5 Utility, surge level 2 EN 50121-4 Rail, ETSI EN 300 386 (48/60V)
Dimensions	Height 2000 mm, option 1600 mm (2052 mm incl. adjustable legs) Width 600 mm Depth 600 mm		

AC Input	
AC connection	TN-S system, 3W + N + PE, (3-phases, neutral and protective earth wires)
Nominal input	220-240 VAC / 3 x 380-415 VAC TN-S system (options: 1-p 100-250VAC or Delta/IT e.g. 3 x 208VAC)
Input range	Max range: 85 – 300 VAC / 3 x 147–528 VAC Rated full power range: 180 – 275 VAC / 3 x 312–476 VAC (TN-S system) See derating curves below, 1200W per rectifier at 120VAC Temporary high voltage range 275 - 300VAC / 3 x 476 - 528VAC, continuous supply not recommended
Input frequency	Rated 45 - 66 Hz, reduced power at 35 - 45 Hz. Shut down at 35 Hz
Main Switch	63A, 4-pole (L1-L2-L3-N)
Rectifier input protection	MCB C16A / rectifier module
	<b>24V 4.5kW   48V 6kW   60V 6kW   110V 6kW   125V 6kW   220V 6kW</b>
Nominal current	8A @ 220/380V   11A @ 220/380VAC
Maximum phase current	12,5A @ 85-130V   12,5A @ 85-180VAC
Recommended mains fuse	3 x 25 A (TN-S)
	<b>24V 9kW   48V 12kW   60V 12kW   110V 12kW   125V 12kW   220V 12kW</b>
Nominal current	16A @ 220/380V   22A @ 220/380VAC
Maximum phase current	25A @ 85-130V   25A @ 85-180VAC
Recommended mains fuse	3 x 25 A (TN-S)
	<b>24V 18kW   48V 24kW   60V 24kW   110V 24kW   125V 24kW   220V 24kW</b>
Nominal current	32A @ 220/380V   44A @ 220/380VAC
Maximum phase current	50A @ 85-130V   50A @ 85-180VAC
Recommended mains fuse	3 x 50 A (TN-S)

DC Output	24V	48V	60V	110V	125V	220V
Grounding	2-pole, floating					
Nominal voltage	24 VDC	48 VDC	60 VDC	108 VDC	120 VDC	216 VDC
Voltage factory setting, 2.27vpc	27.24 VDC	54.48 VDC	68.10 VDC	122.58 VDC	136.20 VDC	245.16 VDC
Voltage range	21-33 VDC	42-59 VDC	51-72 VDC	90-150 VDC	100-160 VDC	178-280 VDC
Static voltage regulation	± 2 % @ load terminals (load, line, temp)			± 1 % @ load terminals (load, line, temp)		
Rectifier output protection	MCB C63A	MCB C50A	MCB C40A	MCB C20A	MCB C20A	MCB C10A
	<b>24V 4.5kW</b>	<b>48V 6kW</b>	<b>60V 6kW</b>	<b>110V 6kW</b>	<b>125V 6kW</b>	<b>220V 6kW</b>
Quantity of rectifiers	Max 3 pcs					
Max current	187.5A @ 24V	125A @ 48V	100A @ 60V	55.5A @ 108V	50A @ 120V	27.8A @ 216V
Max Power	4.5kW	6kW	6kW	6kW	6kW	6kW
	<b>24V 9kW</b>	<b>48V 12kW</b>	<b>60V 12kW</b>	<b>110V 12kW</b>	<b>125V 12kW</b>	<b>220V 12kW</b>
Quantity of rectifiers	Max 6 pcs					
Max current	375A @ 24V	250A @ 48V	200A @ 60V	111A @ 108V	100A @ 120V	55.5A @ 216V
Max Power	9kW	12kW	12kW	12kW	12kW	12kW
	<b>24V 18kW</b>	<b>48V 24kW</b>	<b>60V 24kW</b>	<b>110V 24kW</b>	<b>125V 24kW</b>	<b>220V 24kW</b>
Quantity of rectifiers	Max 12 pcs					
Max current	750A @ 24V	500A @ 48V	400A @ 60V	222 A @ 108V	200A @ 120V	111A @ 216V
Max Power	18kW	24kW	24kW	24kW	24kW	24kW

## Battery Connection alternatives

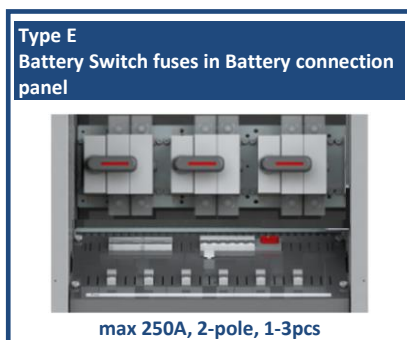
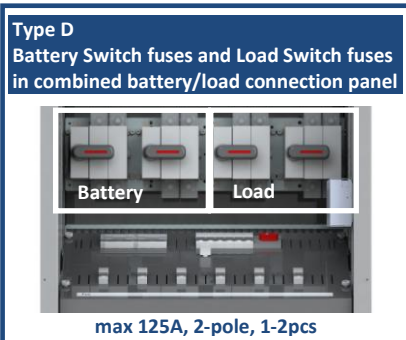
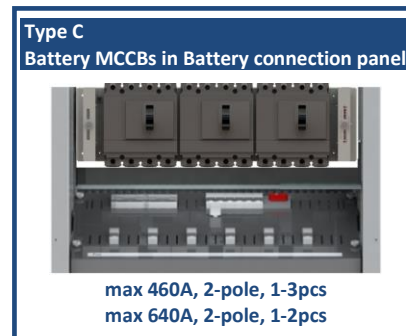
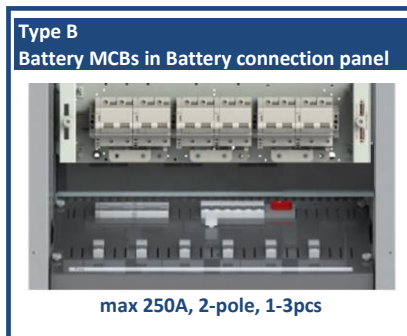
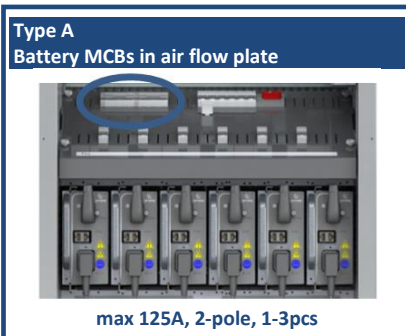

6kW (4.5kW) cabinets	24V 4.5kW	48V 6kW	60V 6kW	110V 6kW	125V 6kW	220V 6kW
MCB battery fuse version	Type B MCB D200A 2-pole, 1-3pcs	Type A MCB D125A 2-pole, 1-3pcs	Type A MCB D125A 2-pole, 1-3pcs	Type A MCB D63A 2-pole, 1-3pcs	Type A MCB D63A 2-pole, 1-3pcs	Type A MCB D63A 2-pole, 1-3pcs
Switch fuse battery fuse version	Type E NH01 200A 2-pole, 1-2pcs	Type D NH00 125A 2-pole, 1-2pcs	Type D NH00 125A 2-pole, 1-2pcs	Type D NH00 63A 2-pole, 1-2pcs	Type D NH00 63A 2-pole, 1-2pcs	Type D NH00 63A 2-pole, 1-2pcs
Battery shelves	Configurable, 0/1/2/3/4 shelves, 4 height variants 245/275/305/335mm, width 530mm, depth 595mm					

12kW (9kW) cabinets	24V 9kW	48V 12kW	60V 12kW	110V 12kW	125V 12kW	220V 12kW
MCB/MCCB battery fuse version	Type C MCCB 368A 2-pole, 1-3pcs	Type B MCB D250A 2-pole, 1-3pcs	Type B MCB D250A 2-pole, 1-3pcs	Type A MCB D125A 2-pole, 1-3pcs	Type A MCB D125A 2-pole, 1-3pcs	Type A MCB D63A 2-pole, 1-3pcs
Switch fuse version	N/A	Type E NH01 250A 2-pole, 1-3pcs	Type E NH01 250A 2-pole, 1-3pcs	Type D NH00 125A 2-pole, 1-2pcs	Type D NH00 125A 2-pole, 1-2pcs	Type D NH00 63A 2-pole, 1-2pcs
Battery shelves	Configurable, 0/1/2/3/4 shelves, 4 height variants 245/275/305/335mm, width 530mm, depth 595mm					

24kW (18kW) cabinets	24V 18kW	48V 24kW	60V 24kW	110V 24kW	125V 24kW	220V 24kW
MCB/MCCB battery fuse version	Type C MCCB 640A 2-pole, 1-2pcs	Type C MCCB 460A 2-pole, 1-3pcs	Type C MCCB 460A 2-pole, 1-3pcs	Type B MCB D250A 2-pole, 1-3pcs	Type B MCB D250A 2-pole, 1-3pcs	Type A MCB D125A 2-pole, 1-3pcs
Switch fuse version	N/A	N/A	N/A	Type E NH01 250A 2-pole, 1-3pcs	Type E NH01 250A 2-pole, 1-3pcs	Type D NH00 125A 2-pole, 1-2pcs
Battery shelves	Configurable, 0/1/2 shelves, 4 height variants 245/275/305/335mm, width 530mm, depth 595mm					

Battery test option	MCB for external discharging test load
---------------------	--

## Load Distribution alternatives



MCB panels



NH00/NH01 fuse panels



Diazed fuse panels



Cylinder fuse panels



Switch fuse panels

Type	Name	Description
8320X0015692	Bulk Output Terminal XL1	Bulk Output Terminal XL1 Screw terminal 95mm <sup>2</sup> 2 x 2-p, top of cabinet (wired)
	Series diode (Blocking diode) module	Semikron 160A, SKKD 162/16, heatsink P3/180
9200X0009815	LD6HF12MCB	Load Distribution panel 12xMCB 2-pole Max DC voltage 250VDC per pole Schneider C60H-DC series Enedo FMU fuse monitoring card
9200X0009819	LD6HF10MCB+AUX	Load Distribution panel 10xMCB 2-pole + aux contact Max DC voltage 250VDC per pole Schneider C60H-DC series
9200X0011397	LD6LF12MCB	Load Distribution panel 12xMCB 2-pole Max DC voltage 72VDC Schneider iC60N series Enedo FMU fuse monitoring card
9200X0015243	LD6LF10MCB+AUX	Load Distribution panel 10xMCB 2-pole + aux contact Max DC voltage 72VDC Schneider iC60N series
9200X0009814	LD6LG24MCB	Load Distribution panel 24xMCB 1-pole Max DC voltage 72VDC Schneider iC60N series Enedo FMU fuse monitoring card
9200X0015239	LD6 230AC 10 x MCB L+N+AUX	Load Distribution panel 10xMCB 2-pole + aux contact AC 230V distribution Schneider iC60N series
9200X0000134	LCF5 HV 2-p 6xNH000	Load Distribution panel 6xNH000 2-pole Enedo DFM fuse monitoring card
832X015887	LCF14 HV 2-p 3xNH01	Load Distribution panel 3xNH01 2-pole Enedo FMU fuse monitoring card
8320X0004157	LCF11 3XOS125 HV	Load Distribution panel 3 x Switch fuse/NH00 2-pole Fuse monitoring by aux MCB
9200X0009817	LD6HF8DIAZ	Load Distribution panel 8 x Diazed fuse 2-pole Enedo FMU fuse monitoring card
9200X0010650	LCF16 HV 2-p 12xE92/32PV	Load Distribution panel 12 x Cylinder fuse 10x38 mm 2-pole Enedo DFM fuse monitoring card
	Load panel screw terminal option	Terminal row, 12 x 2-pole terminals for distribution panels Screw terminals 10mm <sup>2</sup> , top of cabinet (wired)

## Connection terminals

Mains terminal	X1 Mains input screw terminal blocks 10 mm <sup>2</sup> , L1-L2-L3-N-PE
DC output	See alternatives above, connection to screw terminals or to protection device directly
Battery	See battery connection alternatives Internal battery in cabinet: battery cables included External battery: Screw terminals, top of cabinet (wired)
Alarms, Inputs	Configurable relay alarms 12 pcs, Spring terminals 0.75mm <sup>2</sup> ... 1.5mm <sup>2</sup> cable Configurable alarm/temp. inputs 12 pcs, Spring terminals 0.75mm <sup>2</sup> ... 1.5mm <sup>2</sup> cable
Battery test terminals	MCB screw terminals
A+B parallel supply	MCB screw terminals

## Derating curves

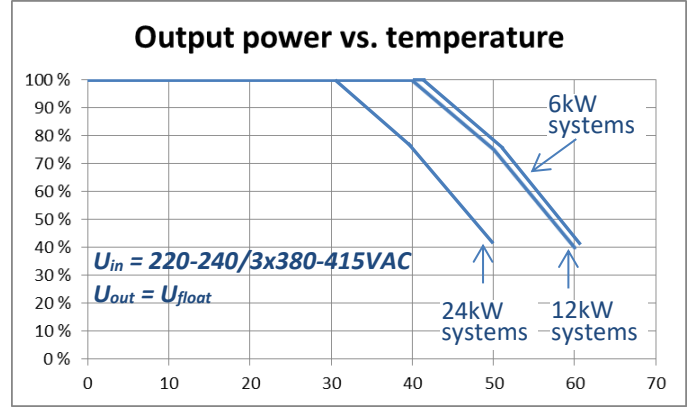
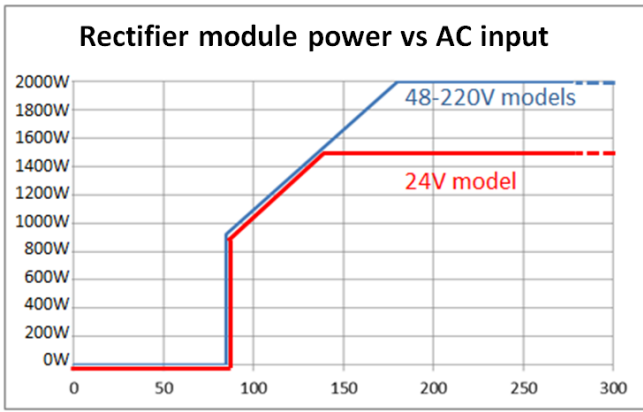

\*) Derating curves are continuous power  
Short time (<1h) 100% power up to +50°C

## Block Diagram, Configurable cabinet options

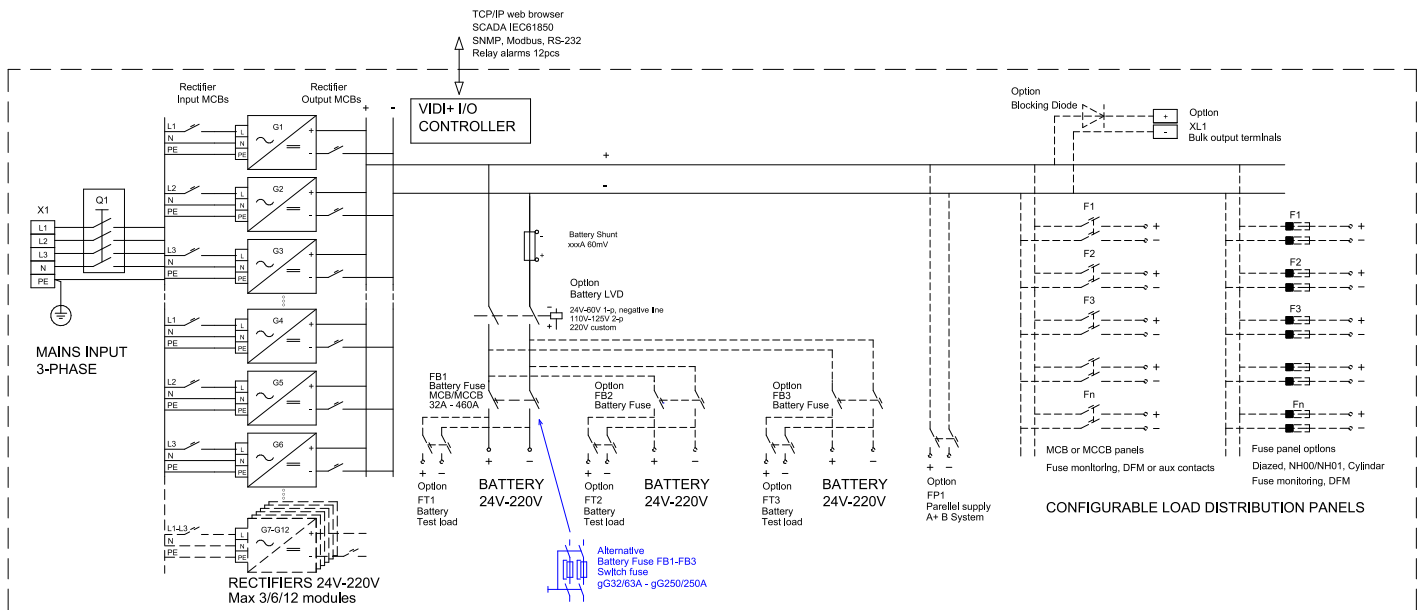

## Block Diagram, Example configuration A+B system, inverter and DC/DC converter options

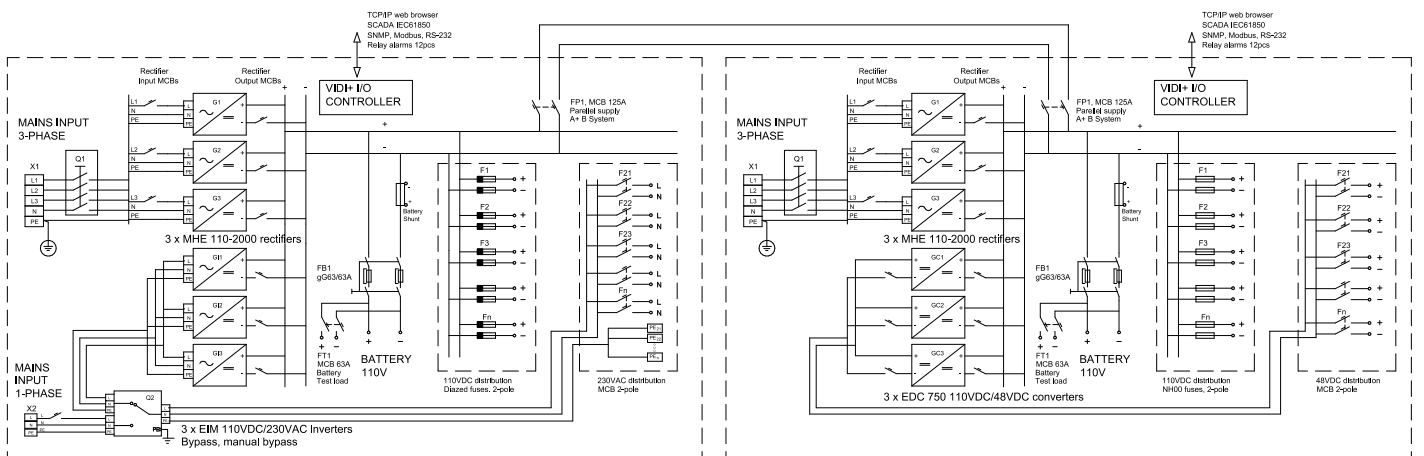

## Layout examples, OPUS cabinet systems



OPUS HE 24-18.0 OC2066  
24VDC 62.5A – 750A  
2 x MCCB 640A battery fuses  
Battery & distribution space



OPUS HE 220-12.0 OC2066  
220VDC 9.3A – 55.5A  
2 x MCB 63A battery fuses  
Battery & distribution space



OPUS HE 110-6.0 OC2066  
110VDC 18.5A – 111A  
Inverter AC power up to 3.6kW  
2 x Switch Fuse 125A batt fuses  
Battery & distribution space



OPUS HE 48-6.0 OC2066  
48VDC 41.7A – 125A  
DC/DC Converter up to 3 x 750W  
2 x MCB 125A battery fuses  
Battery & distribution space



OPUS HE OC0864 Wall Cabinet  
24-220VDC 1.5-12kW  
External batteries  
Inverter and DC/DC Converter  
options

## Order Information

Cabinet Systems MCB/MCCB battery Fuses	Order Number	Cabinet Systems Switch Fuse battery Fuses	Order Number	Voltage / Current
OPUS HE 24-4.5 OC2066 F	9220X0014580	OPUS HE 24-4.5 OC2066 F	9220X0015773	24VDC / 62.5A –
OPUS HE 24-9.0 OC2066 F	9220X0011284	Custom	N/A	24VDC / 62.5A –
OPUS HE 24-18.0 OC2066 F	9220X0011285	Custom	N/A	24VDC / 62.5A –
OPUS HE 48-6.0 OC2066 F	9220X0014581	OPUS HE 48-6.0 OC2066 F	9220X0015776	48VDC / 41.7A –
OPUS HE 48-12.0 OC2066 F	9220X0011266	OPUS HE 48-12.0 OC2066 F	9220X0015633	48VDC / 41.7A –
OPUS HE 48-24.0 OC2066 F	9220X0011267	Custom	N/A	48VDC / 41.7A –
OPUS HE 60-6.0 OC2066 F	9220X0014570	OPUS HE 60-6.0 OC2066 F	9220X0015778	60VDC / 33.3A –
OPUS HE 60-12.0 OC2066 F	9220X0014571	OPUS HE 60-12.0 OC2066 F	9220X0015779	60VDC / 33.3A –
OPUS HE 60-24.0 OC2066 F	9220X0014572	Custom	N/A	60VDC / 33.3A –
OPUS HE 110-6.0 OC2066 F	9220X0014582	OPUS HE 110-6.0 OC2066 F	9220X0015781	110VDC / 18.5A –
OPUS HE 110-12.0 OC2066 F	9220X0015483	OPUS HE 110-12.0 OC2066 F	9220X0011273	110VDC / 18.5A –
OPUS HE 110-24.0 OC2066 F	9220X0011274	OPUS HE 110-24.0 OC2066 F	9220X0015660	110VDC / 18.5A –
OPUS HE 125-6.0 OC2066 F	9220X0014576	OPUS HE 125-6.0 OC2066 F	9220X0015782	125VDC / 16.7A –
OPUS HE 125-12.0 OC2066 F	9220X0014577	OPUS HE 125-12.0 OC2066 F	9220X0015783	125VDC / 16.7A –
OPUS HE 125-24.0 OC2066 F	9220X0014578	OPUS HE 125-24.0 OC2066 F	9220X0015661	125VDC / 16.7A –
OPUS HE 220-6.0 OC2066 F	9220X0014583	OPUS HE 220-6.0 OC2066 F	9220X0015784	220V / 18.5A – 27.8A
OPUS HE 220-12.0 OC2066 F	9220X0011279	OPUS HE 220-12.0 OC2066 F	9220X0015785	220VDC / 18.5A –
OPUS HE 220-24.0 OC2066 F	9220X0011280	OPUS HE 220-24.0 OC2066 F	9220X0015662	220VDC / 18.5A –

Battery shelf versions	Order number	System features
H 245mm, W 530mm, D 595mm	8160X0015479	Battery fuse blocks: See page 3 / price list / configuration
H 275mm, W 530mm, D 595mm	8160X0015218	Load distribution: See page 4 / price list / configuration files
H 305mm, W 530mm, D 595mm	8160X0015480	Battery discharging test KIT, MCB 63A-250A, see config files
H 335mm, W 530mm, D 595mm	8160X0013899	Parallel supply KIT A+B system, MCB 63A-250A, see config

Controllers, Description	Order number	Options, Description	Order number
VIDI+ I/O System controller	94G910	VIDI-BM Block voltage monitoring	9040X0002338

Options, Description	Order number	Options, Description	Order number
Temperature Sensor	94M268	Battery LVD 24V-60V 100-400A 1-P: See price list /	
IP21 Cabinet Roof 50x680x680 mm	9180X0000802	Battery LVD 110-125V 100-200A 2-P: See price list /	
AC over voltage protection KIT 3L-	8320X0004402		